

PT-E-0/PT-E-1/PT-E-2 Series



Certification :

**ISO9001-2015**



## Content

---

1. Introduction \_\_\_\_\_
2. Application \_\_\_\_\_
3. Product Features \_\_\_\_\_
4. Technical data \_\_\_\_\_
5. Dimensions \_\_\_\_\_
6. Electrical connection and debugging \_\_\_\_\_
7. Ordering Guide \_\_\_\_\_
8. Installation and Removal \_\_\_\_\_
9. Sensors cleaning \_\_\_\_\_
10. Transport and Storage \_\_\_\_\_

### 1. Introduction

PT-E-0/PT-E-1/PT-E-2 series adopt imported stainless steel materials, core elements and digital mode circuit design. Realizing sensor linear compensation through digital program. Remote autozero via shorting two pins together. Comply with SIL2, CE safety performance standards. High precision, high stability, low temperature drift and other performance characteristics.

### 2. Application

PT-E-0/PT-E-1/PT-E-2 series is suitable for high-precision extrusion polymerization process control for sheets, composites, films, pipes, chemical raw materials, etc.

### 3. Product Features

Several amplified signal output are optional  
Good stability and anti-interference ability

Remotely autozero  
Internal 80% self-calibration



## 4. Technical Data

### Characteristic

Power Supply	mV/V: 10 V DC(recommended), mA or V : 24V DC
Signal Output	3.33mV/V, 0-5V, 0-10V or 4-20mA
Accuracy	±0.25% FS, ±0.5% FS, ±1% FS
Repeatability	±0.2% FS
Working Temperature	mV/V, mA: 185° F (85°c)
Overload Ability	2x FS
Pressure Range	0-35 Bar---2000Bar
Pressure Unit	psi, Bar, kPa or MPa
Zero Adjustment	mV/V: No, mA: ± 20%
Zero Balance	mV/V: ± 10%: mA: ± 0.5%
Zero Drift (caused by progress)	1.5bar/100° F(3bar/100°)
Bridge Resistance	mV/V: 345 Ω, at least
Overload	mA: 1100 Ω, at most
Insulation Resistance	mV/V: 1000MΩ @50 Vdc mA: 100M Ω @50 Vdc
Shunt Calibration	80% FS ± 1% FS

### Mechanical and Sealing Characteristics

Transducer Technology	Bonded Wheatstone and Wheatstone bridge
Diaphragm Temperature	750° F(400°C), at most
Diaphragm Materials	5 Different Diaphragm Options
Progress Connection	1/2 – 20 UNF and M14 × 1.5, M16 × 1.5, M18 × 1.5 Thread
E – connection	5 PIN,6 PIN,7 PIN,8 PIN
Install Torque	500 in/lbs , at most
Temperature Transducer (optional)	E/J/K/PT100 Type Thermocouple Matches With
Certification	Patented
Certification	CE Certified
Recommend Fitting	
Install Tools	Component GJ
6 Pin E – connection	Component CON06
Matching Connection	
Fix Frame (electric device)	Spares No.:ZJ, cable Fitting, indicator

## 5. Dimensions

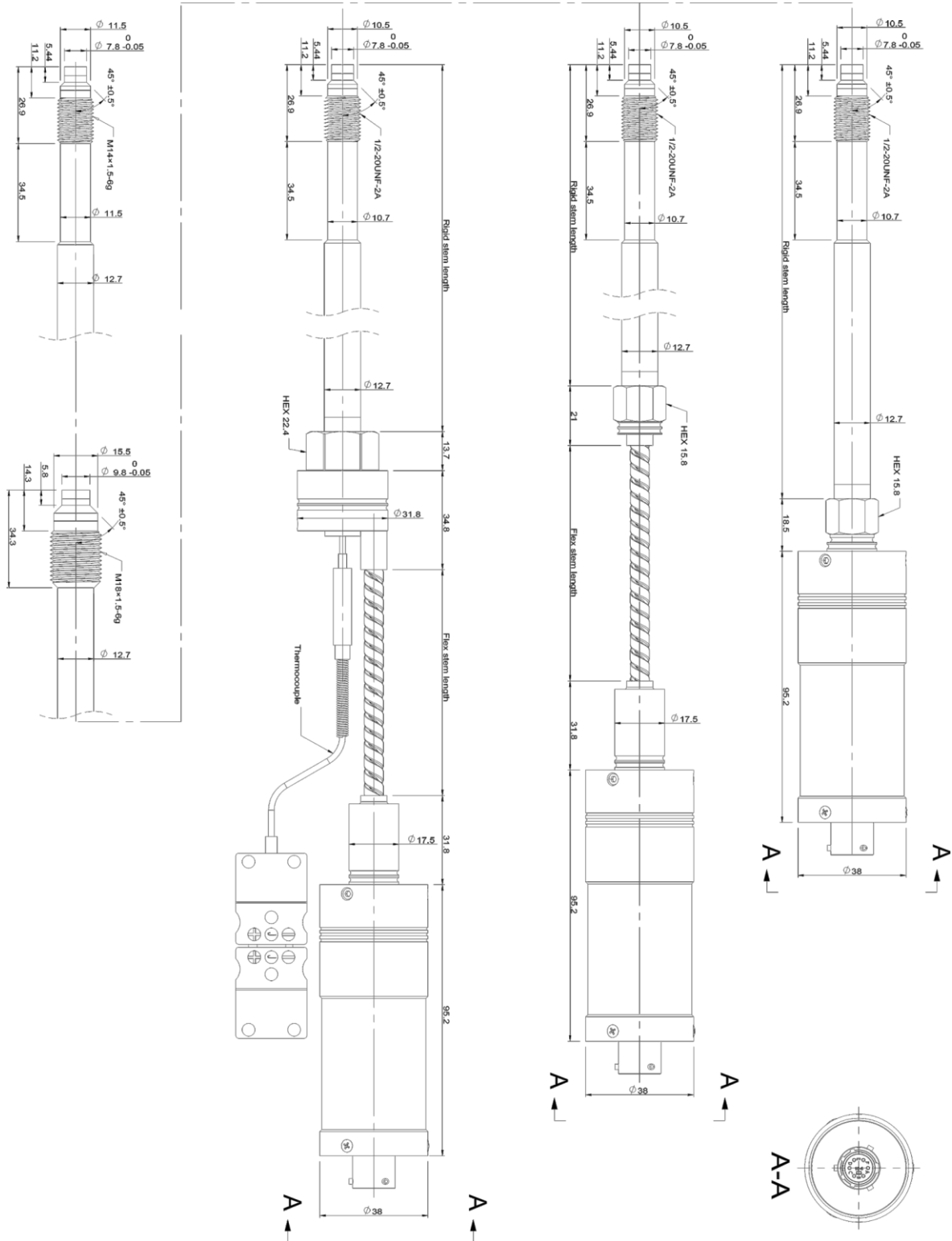

## 6. Electrical connection & Debugging

After the pressure sensor has been installed on the pipeline, the electrical connection must be made in accordance with the connection method shown in the wiring diagram below.

The PT-E-0/PT-E-1/PT-E-2 pressure sensor is equipped with an integrated amplifier circuit. The calibration process must be carried out when the pipeline is heated and the pressure is zero. The zero point is adjusted by activating the autozero function, which is started via shorting two pins together. Start by connecting (see wiring), mV signal does not have this function temporarily, it can be reset to zero through the back-end instrument. Then 80 of the output signal is detected (see wiring diagram), and the pressure sensor will provide a standard 80 measured value signal.

3.33 mV/V Output (4-wire)

6-pin Connector / PT02A - 10- 6P

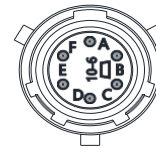
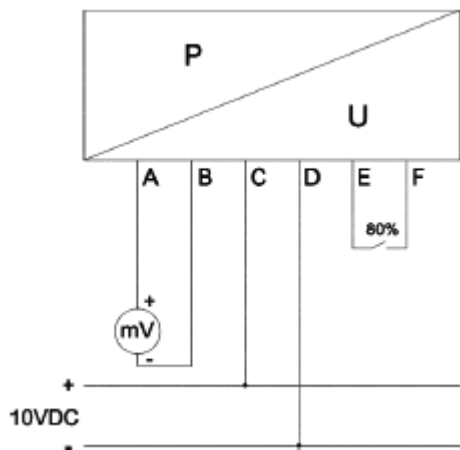

PIN	Function	Wire Color
A	Signal +	Red
B	Signal -	Black
C	Power +	White
D	Power -	Green
E	80% +	Blue
F	80% -	Orange

4 – 20mA Output (2-wire)

6-pin Connector / PT02A- 10- 6P

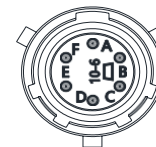
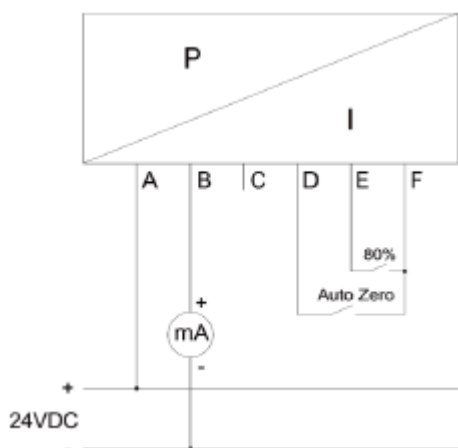

PIN	Function	Wire Color
A	Power +	Red
B	Power -	Black
C		White
D	Shorting D&F to rezero +	Green
E	80% +	Blue
F	Shorting D&F to rezero - /80% -	Orange

0 - 5V / 0 - 10V (4-wire)

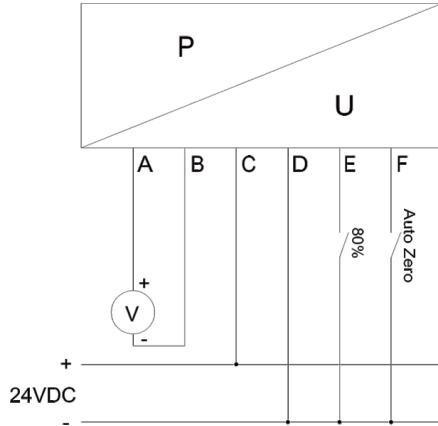

6-pin connector / PT02A-10-6P.

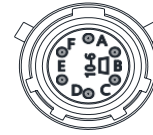

PIN	Function	Wire Color
A	Signal +	Red
B	Signal -	Black
C	Power +	White
D	Power - / 80% - / Shorting D&F to rezero	Green
E	80% +	Blue
F	Shorting D&F to rezero - /80% +	Orange

\* B and D pins are connected internally.

It must be a shielded cable, each core wire is about 0.3 mm<sup>2</sup>, the heat-resistant temperature is not less than 105 C°, each core wire connection terminal should be insulated and protected by heat shrinkable tube, the shielding wire should be connected with the plug-in metal, and the cable should be specially welded carefully, otherwise it may cause signal transmission errors or damage the product. It is recommended to use a dedicated cable that has been soldered by MPS. For extra wires in the cable, each wire needs to be individually wrapped with insulating tape.

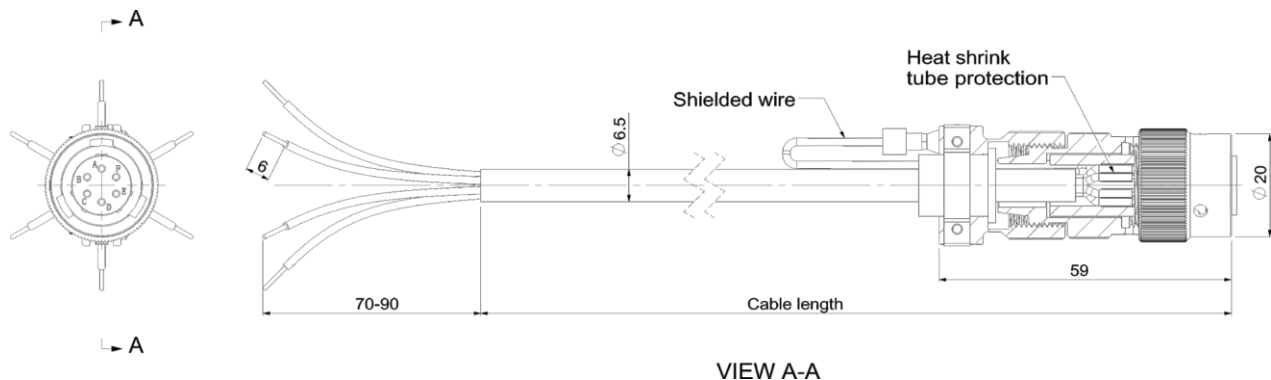

## 7. Installation & Removal

### Installation

When installing the pressure sensor, the sensor hole should be within the size requirement marked in following drawing and the assembly accuracy can be checked by testing bolts. Before installing the sensor, first clean the impurities in the hole and between the threads, then the thread of the sensor is coated with heat-resistant slurry, the screw teeth can be avoided.

The installation force is very important, the installation torque of the sensor can only act on the shaft (hexagon), do not apply any force to the head of the sensor. The housing should be kept away from high temperature areas.

1/2–20 UNF /M14×1.5= Maximum starting torque: 40Nm

M18 x 1.5 = Maximum starting torque: 50 Nm

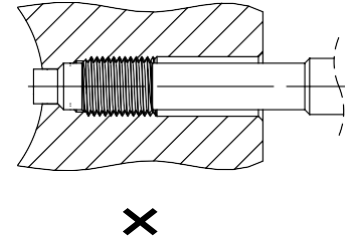
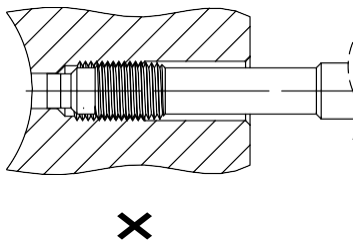
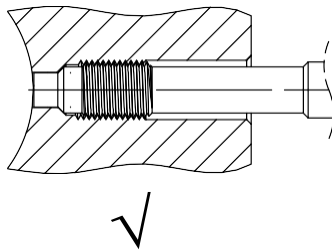

### Removal

The removal of sensor must be done under heated conditions (plastic melting point). When remove the sensor, please note that the diaphragm has no contact pressure. The force to remove the sensor must only be applied on the shaft (hexagon), and do not apply any force to the head of the sensor.

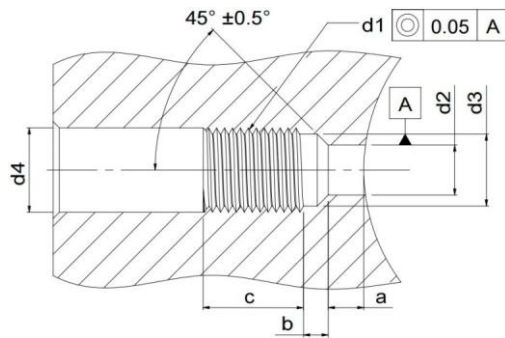

d1	M18×1.5	M14×1.5	1/2-20UNF-2A
d2	Ø9.9 <sup>+0.1</sup>	Ø7.9 <sup>+0.1</sup>	Ø7.9 <sup>+0.1</sup>
d3	Ø16.1 <sup>+0.1</sup>	Ø11.7 <sup>+0.1</sup>	Ø10.7 <sup>+0.1</sup>
d4	Ø20	Ø15	Ø14
a	6.1 <sup>-0.1</sup>	5.7 <sup>-0.1</sup>	5.7 <sup>-0.1</sup>
b	4 <sup>-0.2</sup>	3.2 <sup>-0.2</sup>	3.2 <sup>-0.2</sup>
c	25	19	19

## 8. Sensors cleaning

In order to clean the diaphragm, the sealing surface and thread of the sensor must have the same temperature as the melting point of the plastic. Both the diaphragm and the sealing surface can be wiped clean with a soft cloth, and the thread can be cleaned with a steel brush or a copper brush. . (Do not touch the surface of the diaphragm with the steel brush)

## 9. Transport and storage

The PT-E-0/PT-E-1/PT-E-2 series is usually packaged separately. The front thread of the rigid stem and the diaphragm is protected by a protective cap. This protective cap should be tightened at any time during storage, and only opened during installation.

Notes: Mounting brackets,extension cables,connectors,cleaning kits,drill kits,dummy plug etc accessories,please contact with us.



### 10. RECOMMENDED ACCESSORIES

<p>Pressure indicators &amp; Pressure controllers are available for mated sensors to display and to control the pressure and for further transmission.</p>	
<p>Drilling tool kits. Drilling tool kits include all of necessary drills and taps to prepare a standard transducer mounting holes and contains the special pilot drill required to machine the 45 degree seat. Kits are available for all thread ranges of 1/2"-20UNF, M14x1.5, M18x1.5, M22x1.5 etc.</p>	
<p>Cleaning tool kits. Cleaning tool kits are designed for removing the plastic debris from the mounting hole for melt pressure and temperature sensors to keep from damaging by improperly cleaned holes. Kits are available for all thread ranges of 1/2"-20UNF, M14x1.5, M18x1.5, M22x1.5 etc.</p>	
<p>Simulators. It can be substituted for pressure transducer with mV/V output to simplify the on-line troubleshooting.</p>	
<p>Pressure transducer convertor. Convertors are designed to convert mV/V signal to amplified signal mA or Voltage.</p>	
<p>Connectors and cables. Extension cables assemble a sensor mating connector with stripped leads. The connectors are available with 5pin, 6pin, 7pin and 8pin for mated sensors.</p>	